

## ADRCC350TD/9-18

9-18W Dimmable 350mA  
Constant Current LED Driver

# Drive350

### PRODUCT FEATURES

- Easy Wire Large Terminals
- Dimmable
- Flicker Free Dimming
- Max. DC Loom Length 200m (1.5mm<sup>2</sup> Cable)
- Load:
  - 9...18 PCS x 1W LED (350mA)
  - 3...6 PCS x 3W LED (350mA)
  - 2 PCS x 7W LED (350mA)

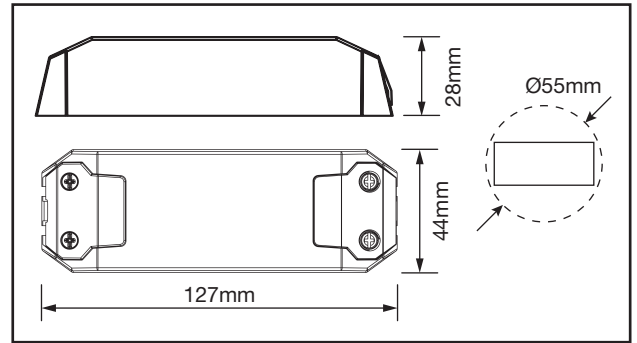

### TECHNICAL SPECIFICATIONS

PRODUCT CODE	ADRCC350TD/9-18
Rated Input Voltage	220-240V AC
Output Current	350mA
Output Power Range	9 - 18W
Input Current	0.16A
Input Frequency	50 - 60Hz
Power Factor	0.95
Efficiency	≥81%
Output Voltage	2.8 - 57V DC
Operating Temperature (°C)	-20°C ~ +50°C
Protection	No Load, Overload, Short Circuit
Recovery	Automatic
Class	II
Lifetime	30,000 Hrs
Guarantee	5 Years

### SERIES WIRING DIAGRAM

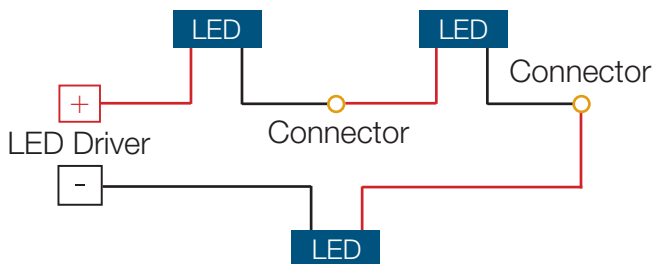

**SERIES WIRING**  
350mA

DESIGNED IN BRITAIN

IP20

240V AC

INDOORS ONLY

CLASS 2

9-18W

DIM

5 YEAR GUARANTEE